

Product Manual

(Short Description)

LEKTROMIK® DS1 Digital soft starter / braking unit

Version: 15DS1-11



Version: 03
Issued: 30.03.2021
Language: English

Table of contents

1	About this document	4
1.1	Structure of the warnings	4
1.2	Signal words and colours	4
1.3	Symbols	4
1.3.1	Mandatory action symbols	4
1.3.2	Warning symbols	5
1.3.3	Other symbols	5
1.3.4	Representation of instructions	5
1.4	Definition of key terms	5
2	Identification and information	6
2.1	Product data	6
2.2	Manufacturer	6
2.3	Intended use	6
2.3.1	Area of application and service life of the product	6
2.4	Reasonably foreseeable misuse	7
2.5	General information	7
2.5.1	Warranty and liability	7
2.6	Target groups for the operating instructions	7
2.6.1	Target group matrix	8
2.6.2	Target group definition	8
3	Safety instructions	8
3.1	General safety instructions	8
3.1.1	Duties of the personnel	9
3.2	Additional instructions	9
4	Product description	10
4.1	Overall view	10
4.2	Product features	10
4.3	Block diagram	11
4.4	Construction and function of the product	12
4.4.1	Description of the construction	12
4.4.2	Functional description	13
4.5	Technical Data	13
4.5.1	Product name plate with CE marking	15
4.5.2	CE-conformity	15
4.6	Product dimensions	16
4.7	Connections	17
4.8	Circuit recommendations	18
4.9	Planning the installation	21
4.9.1	EMC - Electromagnetic compatibility	22
5	Menu structure	23
5.1	Parameterization and password level	23
5.2	Initial setup menu	23
5.3	Main menu	24
5.4	Sub-menus	25
5.4.1	Messages sub-menu	25
5.4.2	Device info sub-menu	26

5.4.3	Display sub-menu.....	26
5.4.4	Settings sub-menu	27
5.4.5	Basic setting sub-menu	28
5.4.6	Soft start sub-menu	28
5.4.7	Soft stop sub-menu	30
5.4.8	Braking sub-menu	31
5.4.9	Control inputs sub-menu	31
5.4.10	Control outputs sub-menu	32
5.4.11	Parameter sets sub-menu	33
5.4.12	Parameter list sub-menu	34
6	Control.....	36
6.1	Control inputs	36
6.2	Control outputs	37
6.3	Operating modes and conditions	37
6.3.1	Switch on control voltage	37
6.3.2	Standby	38
6.3.3	Soft start	38
6.3.4	End of ramp-up.....	39
6.3.5	Soft stop	39
6.3.6	Braking	39
6.3.7	Cancellation.....	40
6.3.8	Switching off (DC 24V)	41
7	Appendix	43
7.1	Lists	43
7.1.1	List of figures	43
7.1.2	List of tables	44

1 About this document

This chapter explains how information is presented in this document.

1.1 Structure of the warnings

The combination of a signal word in connection with a pictogram classifies the respective warning information. The symbol can vary depending on the type of danger.

DANGER



The signal word (here: Danger) is followed by a description of the type and source of the potential danger.

A description of consequences that will occur if no measures are taken to avert the danger follows next.

The warning is concluded with a description of the measure to be taken to avert the danger.

1.2 Signal words and colours

The following signal words are based on DIN ISO 3864-2 and are used in this documentation.

The safety colours have been taken from the standard ISO 3864-1. The design conforms with DIN EN 82079-1 and ANSI Z 535.4.

Signal word	Explanation
DANGER	Indicates a dangerous situation that will result in serious or fatal injury if ignored.
WARNING	Indicates a hazardous situation which, if not avoided, can result in fatal or serious injury.
CAUTION	Indicates a dangerous situation that can result in minor injury and property damage if ignored.
NOTE	Indicates ways to make operation easier, as well as cross-references.

Table 1: Signal words

1.3 Symbols

A number of the following specific safety symbols per DIN EN ISO 7010 are used in the corresponding text passages of these operating instructions and require special attention depending on the combination of signal word and symbol.

Please note the differentiation between

- Mandatory action symbol – stipulates an action to be taken (e.g. wearing safety goggles).
- Warning symbol – illustrates a hazard source and thus supplements the warning instructions.

1.3.1 Mandatory action symbols

Symbol	Explanation	Symbol	Explanation
	Observe instruction		General mandatory action symbol

Table 2: Mandatory action symbols

1.3.2 Warning symbols





Symbol	Explanation	Symbol	Eplanation
	General warning signs		Warning of electrical energy
	Warning of electrostatic discharge		Warning of non-ionising radiation

Table 3: Warning symbols

1.3.3 Other symbols





Symbol	Explanation	Symbol	Explanation
	Dispose of packaging material in accordance with regulations		Recycling

Table 4: Other signs

1.3.4 Representation of instructions

Action instructions guide the reader through actions step-by-step. The individual components of instructions are the following:

The topic of instructions as headline

-  The objective of the instructions
-  Potentially needed tools or aids
 1. A first action step
 2. Further steps follow
-  The result concludes the action

1.4 Definition of key terms



NOTE

Disregard of definitions

Read the definitions carefully. In order to ensure safe handling of the product, the entire information contained in these operating instructions must have been read and understood.

Term	Abbreviation	Definition
Authorised personnel		Employees who are authorised to carry out specific jobs with and at the product according to the target group matrix and definitions of this product manual.
Personal protective equipment	PPE	Equipment that is intended to be used and worn by the personnel to protect themselves against hazards posed at their workplaces.
Other tasks		Are tasks that are to be carried out only by specialist personnel in accordance with the target group definitions. This includes, for example, installation, initial commissioning, etc.

Table 5: Definition of key terms

2 Identification and information

This section contains information on the product and its identification. This section is aimed at all specified target groups.

2.1 Product data

Designation:	LEKTROMIK® DS1
Type / Series:	Digital soft starter / d.c. injection brake 15DS1-11
Order number:	8110.322
Country of origin:	Germany

2.2 Manufacturer



KIMO Industrial Electronics GmbH

Am Weichselgarten 19
91058 Erlangen
Germany

E-Mail: info@kimo.de

Tel: +49 9131-6069-0

Fax: +49 9131-6069-35

Web: www.kimo.de

2.3 Intended use

The product LEKTROMIK® DS1 is used for the soft starting/stopping or braking of three-phase induction motors. The LEKTROMIK® DS1 is intended for mounting in a suitable housing (e.g. cabinet) as a part of a machine or electrical system.

Any other use of the product is deemed not to be in the manner intended and thus improper. KIMO Industrial Electronics GmbH accepts no liability for damage resulting from such improper use.

Intended use also includes:

- following all instructions in these operating instructions
- compliance with all safety and warning instructions
- compliance with the maintenance regulations

2.3.1 Area of application and service life of the product

The intended area of application of the product is for commercial use.

The service life of the product is - among other things - dependent on the following factors:

- application environment
- intensity of use
- compliance with the maintenance regulations specified by the manufacturer (see chapter 0 on page 43).

2.4 Reasonably foreseeable misuse

Reasonably foreseeable misuse that could result in hazards posed to the personnel, third parties or to the product, for all operating modes, includes:

- using the product contrary to its intended use
- operating the product outside the physical application limits (see chapter 4.5 Technical Data from page 13)
- using the product contrary to the stipulations in the operating instructions
- using the product with obvious faults or damage (e.g. broken connections, housing damage, etc.)



CAUTION

Unauthorised modifications to the product

Unauthorised modifications may result in the risk of sustaining injuries.

Never carry out unauthorised modifications to the product without prior consent by KIMO Industrial Electronics GmbH.

2.5 General information

2.5.1 Warranty and liability

In principle the “Terms of Trade” of KIMO Industrial Electronics GmbH apply.

Warranty and liability claims in the event of personal injury or property damage will be excluded if the damage results from one or more of the following causes:

- improper use of the product
- use of the product contrary to its intended use
- disregard of the safety and warning instructions in the operating instructions
- unauthorised structural modifications of the product
- deficient performance of the specified maintenance measures
- disaster situations with the effects of foreign objects or force majeure

The operating instructions must be read prior to handling the product. The operating instructions familiarise the personnel with the handling of the product and inform them of the life phases of the product in detail.

Safety and warning instructions in these operating instructions must always be adhered to and observed. For further questions that go beyond the scope of these operating instructions, please contact KIMO Industrial Electronics GmbH at any time.

The guarantee period for the LEKTROMIK® DS1 is one year from the delivery date, in accordance with the Terms of Trade. The guarantee applies only if the recommended product protection has been employed.

These operating instructions, including all safety and warning instructions, must be:

- observed, read and understood by the personnel working with the product
- easily accessible to everyone at all times
- consulted in the case of even the slightest doubt

2.6 Target groups for the operating instructions



WARNING

Personnel lacking the proper qualification

Improper qualification of personnel causes a risk of serious injuries.

Observe the target group matrix and definition.

Only carry out the tasks you are authorised to.

Consult your superior if you have any questions.

The target group matrix and definitions are based on the European and German qualifications framework.

2.6.1 Target group matrix

At different life cycles of the product, personnel with varied expertise come into contact with the product.

Tasks	Operating personnel (DQR/EQR Level 1)	Specialist personnel (DQR Level 3/EQR Level 4)
Operation	X	X
Other		X

Table 6: Target group matrix

NOTE Observe Chapter 1.4 Definition of key terms on page 5.

2.6.2 Target group definition

2.6.2.1 Operating personnel

A person (physically/mentally capable adult) who has been instructed and trained by specialised technicians for the work assigned (e.g. product start-up, shut-down and operation) and for potential hazards posed in the event of improper conduct.

2.6.2.2 Specialised technicians

A person (physically/mentally capable adult) who has gained special skills and experience due to their professional training. These persons must be familiar with applicable standards, able to evaluate work assigned to them (e.g. instructing personnel, product start-up, shut-down and operation). Specialised technicians must be able to identify mechanical and electrical dangers and potentially hazardous situations.

3 Safety instructions

This chapter includes general safety information and safety-related instructions for the product. This section is aimed at all specified target groups.



CAUTION

Disregard of the operating instructions

Disregard of the operating instructions results in the risk of sustaining injuries.

Read and observe the operating instructions prior to starting work with the product.

The product has been constructed in accordance with state-of-the-art technology and generally accepted safety rules. There is a risk of personnel injury or property damage in the event of improper use, incorrect installation or incorrect operation. The company operating the product or the persons assigned by it is/are liable for injuries and/or property damage resulting from non-compliance with the instructions provided in the operating instructions.

3.1 General safety instructions



DANGER

Electrical energy

Risk of injury or death due to electrical energy.

Have work on the electrical components carried out only by authorised personnel.

Check the electrical components in accordance with the maintenance instructions.

Switch the product on only if the check of the electrical components confirms that there are no faults.

If faults are discovered during the checking of the electrical components, inform your supervisor.

Observe the five safety rules (EN 50110-1 Operation of electrical installations):

- Disconnect
- Secure against being switched on again
- Ensure that product is in de-energised state
- Earth and short-circuit the product
- Cover or isolate neighbouring live parts



WARNING

Negligence with the product

Negligence in handling the product results in the risk of sustaining injuries.

Ensure that you comply with the instructions in these operating instructions when dealing with the product.



NOTE

Electrostatic discharge

Electronic components are endangered by electrostatic discharge.

Take appropriate precautions when working with the product.

3.1.1 Duties of the personnel

The personnel working near the product have a shared responsibility to ensure safety and protect health at the workplace. Apparent safety deficiencies must be reported to a superior without delay.



WARNING

Operation with faults or malfunctions

Operation with faults or malfunctions can present a risk of serious injury.

Check the product in accordance with the maintenance instructions.

3.2 Additional instructions

In addition, observe and follow the

- applicable mandatory accident prevention regulations
- generally accepted technical rules for safe and professional work
- existing environmental protection regulations
- other applicable regulations

4 Product description

This section contains information pertaining to the installation and function of the product. This section is aimed at all specified target groups.

4.1 Overall view

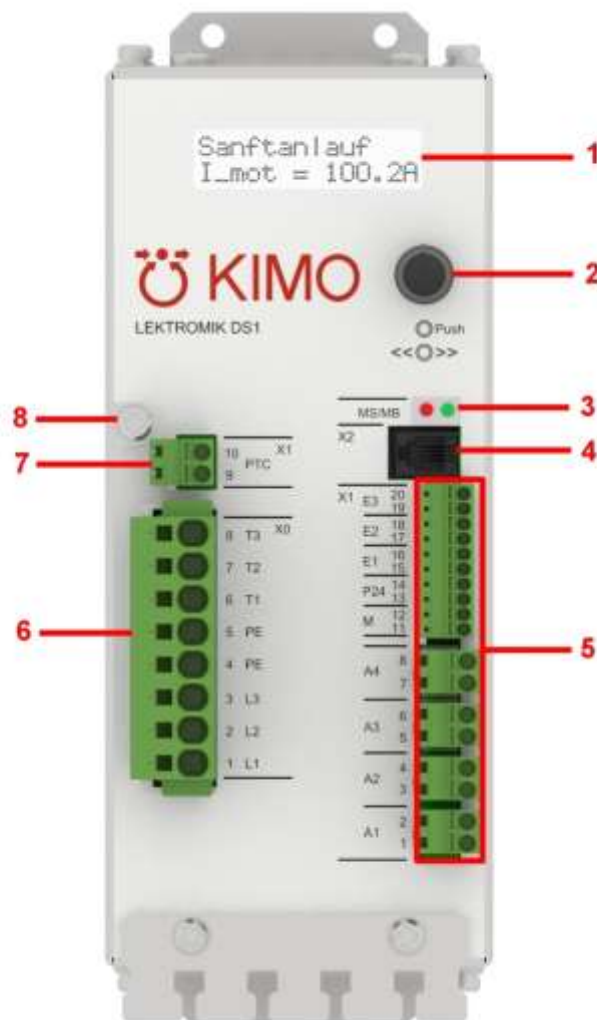

- | | |
|---------------------------------|---------------------|
| 1 Display | 5 Connection points |
| 2 Control knob | 6 Connection points |
| 3 Fault and status LED | 7 Connection points |
| 4 Interface / Service interface | 8 Housing screw |

Figure 1: Front view

4.2 Product features

The LEKTROMIK® DS1 is an electronic motor control unit for soft starting, soft stopping and wear-free braking of three-phase motors, in particular those in efficiency classes IE1 to IE3.

The features of the LEKTROMIK® DS1 are summarised below:

- Three-phase controlled soft start - adjustable torque characteristic to protect the drive components in comparison to direct starting or star-delta switchover
- Current limit – reduction of the starting current during the start phase
- Phase failure and rotary field monitoring
- Integrated bypass relays – minimisation of the power losses through internal bridging of the power semiconductors

- Soft stop – controlled ramp-down for loads with a large frictional component, preventing stopping too abruptly
- Ramp-up and ramp-down time separately adjustable
- Integrated DC current brake, fully controlled, 2-phase, reliable electrical braking of the drive
- Brake function fulfils the requirements for PL = b per DIN EN ISO 18349-1 (in preparation)
- Integrated zero speed detection – detection of motor zero speed condition and monitoring of the zero speed time
- Increase of motor current by 70% possible when power section is connected in delta connection
- Integrated monitoring of the motor winding temperature
- Optional interfaces – modular extension with interfaces: CANOpen, Ethernet, PROFINET, Modbus-TCP (further optional interfaces are possible on request)
- Plug-in/push-in control terminals — rapid installation of pre-assembled control cables when used in serial manufacturing
- Protection to IP20
- Fault LED – immediate recognizability of a fault
- Certification per DIN EN ISO 19085-1: 2018 optional – see technical data for additional standards
- Microprocessor controlled
- Simple operation via rotating encoder knob and two-line display
- Pre-defined parameter sets for different applications.
- Two memories for user parameter sets

4.3 Block diagram

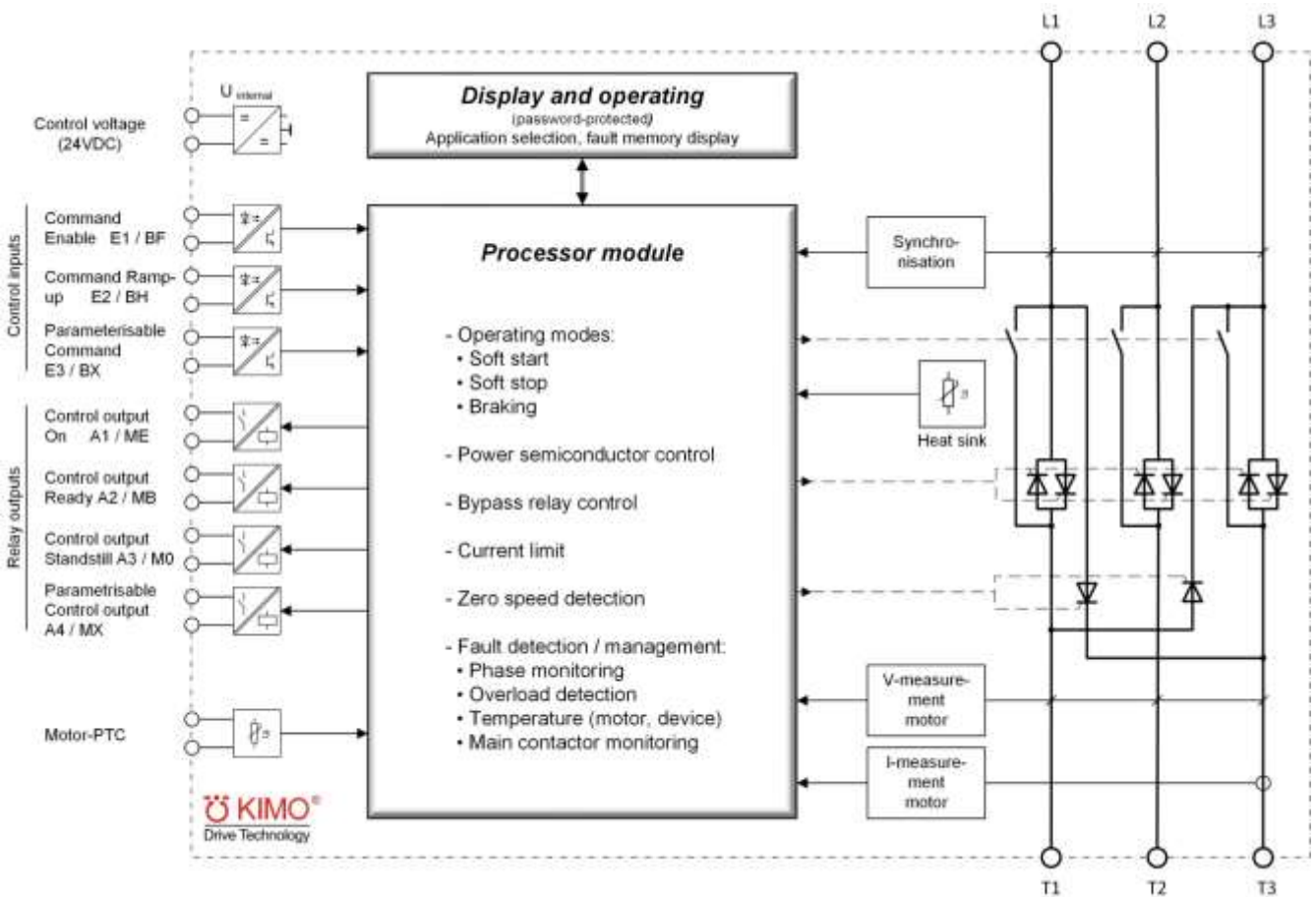

Figure 2: Block diagram

4.4 Construction and function of the product

4.4.1 Description of the construction

The processor module, the power module and the display module are integrated into the housing.

The processor module controls and monitors all functions of the device, processes the inputs and controls the outputs. The processor module reads in the following variables:

- Synchronisation signals (3-phase) from the power supply L1, L2 and L3
- Motor voltage (3-phase) on T1, T2 and T3
- Motor current (1-phase) in T3
- Heat sink temperature.

Thyristors, relays and other power electronic components are gathered together in the power module. Three bypass relays are directly controlled by the processor module. The actuation of the thyristor groups is implemented via an optocoupler to ensure electrical isolation.

The LEKTROMIK® DS1 has a control and display unit on the front (display and control knob). Operating parameters can be displayed and the configuration and parameters changed via this unit.



- 1 Display
- 2 Control knob

Figure 3: Display and control knob

Display

The LEKTROMIK® DS1 is equipped with a 2-line display on the front for displaying operating conditions and configuration/parameters. The backlight has adjustable duration. The backlight switches on as soon as the rotary encoder or button is actuated.

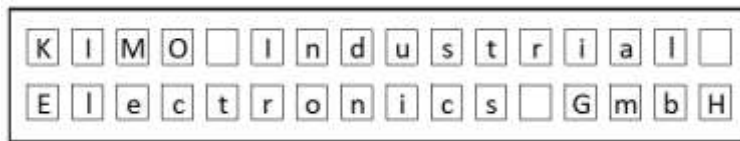

Figure 4: Two-line LCD display (example)

Control knob

The control knob is located on the right under the display on the front. It has the following functions:



Illustration	Function	Explanation
	Turn	<ul style="list-style-type: none"> • Navigation in the status displays • Navigation in the menus, selection and entering of values
	Press	<ul style="list-style-type: none"> • Confirmation of the input/selection • Menu item selection

Table 7: Control knob functions

LED indicators

There are two LED indicators on the control board of the LEKTROMIK® DS1:





Illustration	LED indicators	Explanation
	Fault LED MS	<ul style="list-style-type: none"> • LED is off • No fault present
		<ul style="list-style-type: none"> • LED illuminates or flashes red. • Fault present
	Operating LED MB	<ul style="list-style-type: none"> • LED is off • LEKTROMIK® DS1 is not ready for operation
		<ul style="list-style-type: none"> • LED illuminates • LEKTROMIK® DS1 is ready for operation

Table 8: LED indicator functions

4.4.2 Functional description

Three anti-parallel thyristor modules are used in a fully controlled circuit for the soft start/stop. The motor voltage is provided by the three phase-controlled thyristors. In doing so, the supply frequency to the motor remains identical to the mains frequency. The drive torque can be parameterised within a large range.

Separate thyristors are used for the braking in order to rectify the line voltage in a controlled manner. The DC current created flows through two windings of the motor, creating a stationary magnetic field that works against the rotational movement of the rotor. The control of the thyristors enables the adjustment of the braking torque within a large range.

Due to a modified synchronization the power-unit may be operated in delta connection. Thus it is possible that the device can be used with motors with 70% higher rated current. Precondition: All six, not connected winding ends in the motors are available for connection and the motor is switched to delta.

4.5 Technical Data

General technical data	
Voltage:	3 AC 200 bis 480 V, -15/+10 %
Frequency:	50 bis 60 Hz +/- 2%
Type of supply system	only for use on TT/TN systems with earthed neutral
Overvoltage category:	III (EN 60664-1)
Rated insulation voltage to PE:	AC 300 V
Rated impulse withstand voltage:	4 kV
Protective class:	I (EN 61140), basic insulation und PE connection (protective earth). The operating company is responsible for the proper connection of the PE connection (protective earth).
IP protection:	IP20 (EN 60529), finger protection
Protective separation:	Control voltage, control inputs and outputs are securely separated from each other and from the power section.
Electromagnetic compatibility:	
- emission	EN 60947-4-2, environment B (EN 55011, class B). While conti-nuously operated the limit for the operation on the public grid in residential, commercial, industrial and light-industrial environments is met.
- immunity	EN60947-4-2, environment A. The product withstands the interference level of industrial areas.

Specific technical data (continuation)	
Rated duty :	Uninterrupted duty (EN 60947-4-2)

Table 9: Product technical data (general)

Environmental conditions	
Permissible temperatures Normal operation: Storage: Transport (short-term):	0 to 40 °C -25 to 55 °C -25 to 70 °C
Climatic conditions:	Class 3K3 (EN 60721-3-3) 5 to 85% relative humidity, no condensation permitted
Max. installation altitude:	2000 m above sea level ≥ 1000 m: 1.5%/100 m power derating
Pollution:	Pollution degree 2: (EN 60664-1), only dry, non-conducting contamination, infrequent light condensation permitted whilst switched off

Table 10: Technical Data – Environmental conditions

Specific technical data													
Designation:	LEKTROMIK® DS1												
Type:	15DS1-11												
Order number:	8110.322												
Rated motor power: Standard connection Delta connection (soft start/stop only)	<table border="0"> <tr> <td>3AC</td> <td>230 V</td> <td>400 V</td> <td>480 V</td> </tr> <tr> <td></td> <td>7,5 kW (up to 8,5 kW)</td> <td>15 kW</td> <td>18,5 kW</td> </tr> <tr> <td></td> <td>15 kW</td> <td>26 kW</td> <td>30 kW</td> </tr> </table>	3AC	230 V	400 V	480 V		7,5 kW (up to 8,5 kW)	15 kW	18,5 kW		15 kW	26 kW	30 kW
3AC	230 V	400 V	480 V										
	7,5 kW (up to 8,5 kW)	15 kW	18,5 kW										
	15 kW	26 kW	30 kW										
Minimum motor power:	10% of the respective nominal power												
Rated current:	30 A												
Starting current:	max. 6-time rated current												
Braking current:	max. 5-time rated current												
Control voltage / current:	24 V DC +/- 20 %, max. 1 A												
Control inputs:	Optocoupler, DC 24 V, ca. 5 mA, U ≤ 5 V = logic 0, U ≥ 15 V = logic 1												
PTC input:	Motor-PTC or switching contact, U _r = DC 5 V R _{PTC} ≥ 4 kOhm = logic 0, R _{PTC} ≤ 750 Ohm = logic 1												
Control outputs: Switching voltage range: Switching current:	Relay AC 250 V (OVC II), DC 24 V, max. 2 A												
Device type: Utilisation category / load cycle ¹⁾ : Device variant:	Bridged semiconductor controller (EN 60947-4-2) 30A: AC53b: 6-6: 354 1 (soft start, full-load control, soft stop, braking)												
Power losses in continuous operation:	ca. 20 W (after ramp-up)												
Semiconductor fuses ²⁾ :	20,000 A2s, max. switch-off I ² t – semiconductor fuse value at 25 °C												
Rated conditional short-circuit current:	10 kA with fuse: Jean Müller N5013805 63A gG, coordination type 1 Jean Müller R5214350 100A gR, coordination type 1												
Connection wire connecting capacity ³⁾ : Mains and motor connection: Control connection:	<table border="0"> <tr> <td>2,5 to 6 mm²</td> <td>X0</td> </tr> <tr> <td>0,75 to 2,5 mm²</td> <td>X1.1 to X1.10</td> </tr> <tr> <td>0,5 to 1,5 mm²</td> <td>X1.11 to X1.20</td> </tr> </table>	2,5 to 6 mm ²	X0	0,75 to 2,5 mm ²	X1.1 to X1.10	0,5 to 1,5 mm ²	X1.11 to X1.20						
2,5 to 6 mm ²	X0												
0,75 to 2,5 mm ²	X1.1 to X1.10												
0,5 to 1,5 mm ²	X1.11 to X1.20												

Specific technical data (continuation)	
Cooling:	Convection, optional fan
Cooling clearance:	50/50/10/10 mm Top/bottom/left/right Additional heating due to neighboring devices/products/machines must be prevented.
Permissible heat sink temperature:	Depending on current motor current: <ul style="list-style-type: none"> • up to 4-times of rated current of device: 85 °C • up to 6-times of rated current of device: dropping linearly to 65 °C
Mass:	3 kg
Dimensioning of the product:	235 / 90 / 195 mm height / width /depth

Table 11: Product technical data (specific)

- Utilization category / load cycle e.g. 30 A: AC-53b: 6-6: 354, so:
 - 30 A: Rated current $I_{Ndevice}$
 - AC-53b: Soft start with bridging during operation with three-phase squirrel-cage motor
 - 6-6: Max. starting current is $6 \cdot I_{Ndevice}$ for 6 s
 - 354: Min. waiting time [s] between last use and new start-up at max. starting current/time
- Not included in the scope of supply
- Cable cross section (fine wire with end ferrules)

4.5.1 Product name plate with CE marking

The product name plate is located on the right side of the product on the housing.

 D - 91058 Erlangen Am Weichselgart. 19	LEKTROMIK 15DS1-11	 IP 20
Nennleistung/ Rat power/ Puissance nom. (400 V)	kW	15 kW
Nennstrom/ Rat current/ Courant nominale	A	30 A
Anwendungs-Klasse/ Utilization category/ Categorie d'emploi IEC 947-4-2	AC-53a:	AC-53b: 6-6:354
Nennspannung/ Rated voltage/ Tension nominale	3 AC 200-480 V 50-60 Hz	
Steuerspannung/ Control supply/ Tension d'aliment. de commande	DC 24 V	
Best. Nr./ Order no./ No. de comm.	8110.322 Vors. AA	 8110T0829001 0000000
		Made in Germany

Figure 5: Name plate (example)

4.5.2 CE-conformity

Our units are matching the relevant EU-directives and regulations and do fulfill the CE-conformity. On demand we may supply the CE- declaration of conformity. Any other certifications, e.g. like UL, are noted separately.

4.6 Product dimensions

Illustration of the product specifying the space requirement (values in mm).

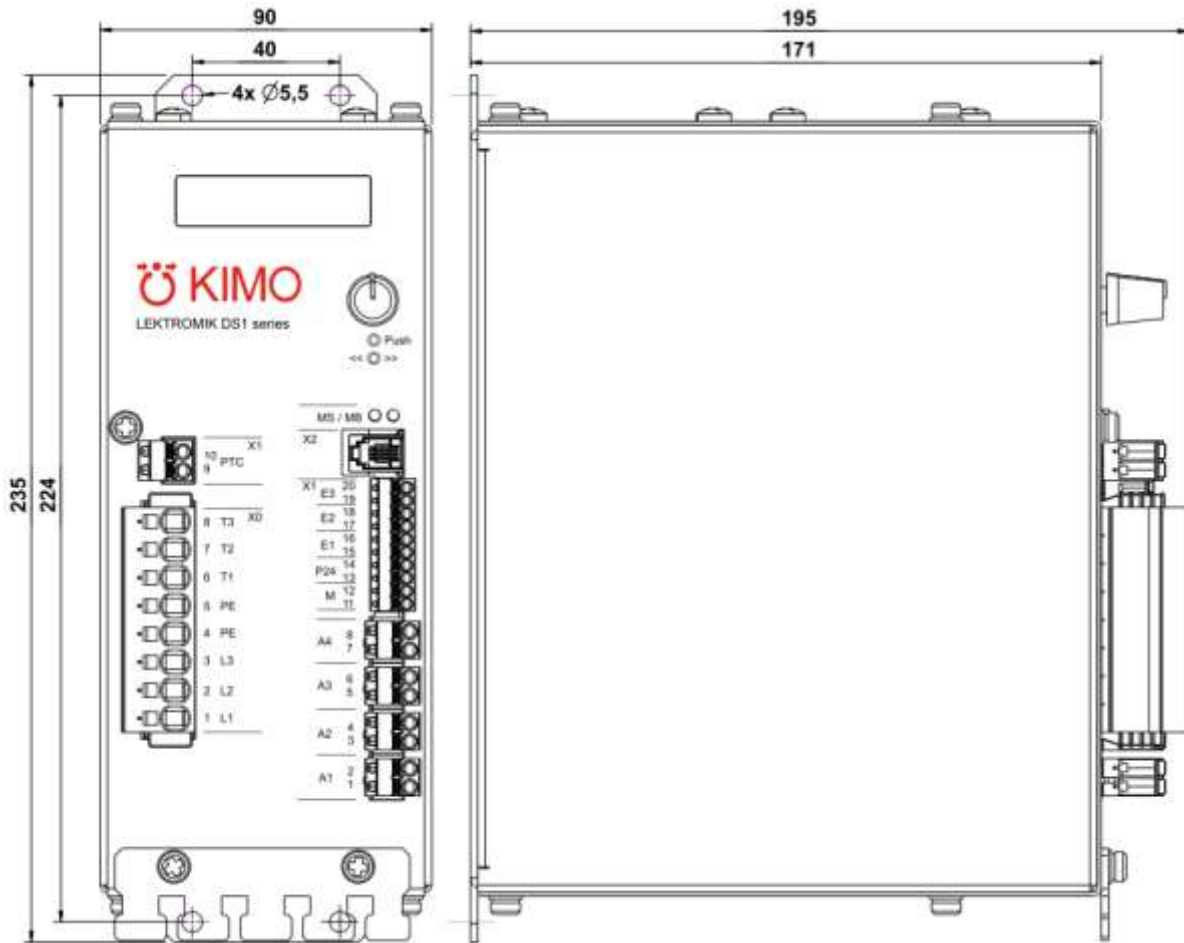

Figure 6: Front and side view of the product

4.7 Connections

NOTE Ensure:

- The line voltage present matches with the line voltage specified for operating the product,
- The cross section of the PE connection (protective earth) and connection cables,
- The connection data in chapter 4.5 Technical Data from page 13 and in the circuit diagram.

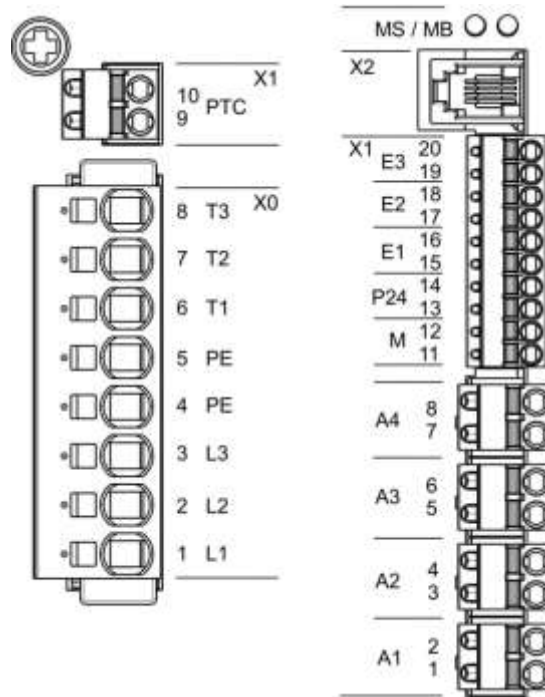

Figure 7: Arrangement of the connection terminals

	Terminal	Designation	Signal/Function	Explanation
Power unit	X0: 1, 2, 3	L1, L2, L3	Supply connection	3 AC 200 to 480 V
	X0: 6, 7, 8	T1, T2, T3	Motor connection	
	X0: 4, 5	PE	Protective earth	
Control unit	X1: 1, 2	A1	ME Control output on	Relay contact (N0)
	X1: 3, 4	A2	MB Control output ready	Relay contact (N0)
	X1: 5, 6	A3	M0 Control output zero speed	Relay contact (N0)
	X1: 7, 8	A4	MX Control output parameterizable	Relay contact (N0)
	X1: 9, 10	PTC	Motor temperature monitoring connection	Motor PTC or temperature switch
	X1: 11, 12	M	Control voltage 0V	
	X1: 13, 14	P24	Control voltage + 24V	
	X1: 15, 16	E1	BF Enable command	Optocoupler, 15 -, 16 +
	X1: 17, 18	E2	BH Ramp-up command	Optocoupler, 17 -, 18 +
X1: 19, 20	E3	BX command parameterizable	Optocoupler, 19 -, 20 +	
Interface	X2		Service interface	RJ10, RS232

Table 12: Explanation – Arrangement of the connection terminals

4.8 Circuit recommendations

NOTE K1 has to be controlled bay A1/ME.

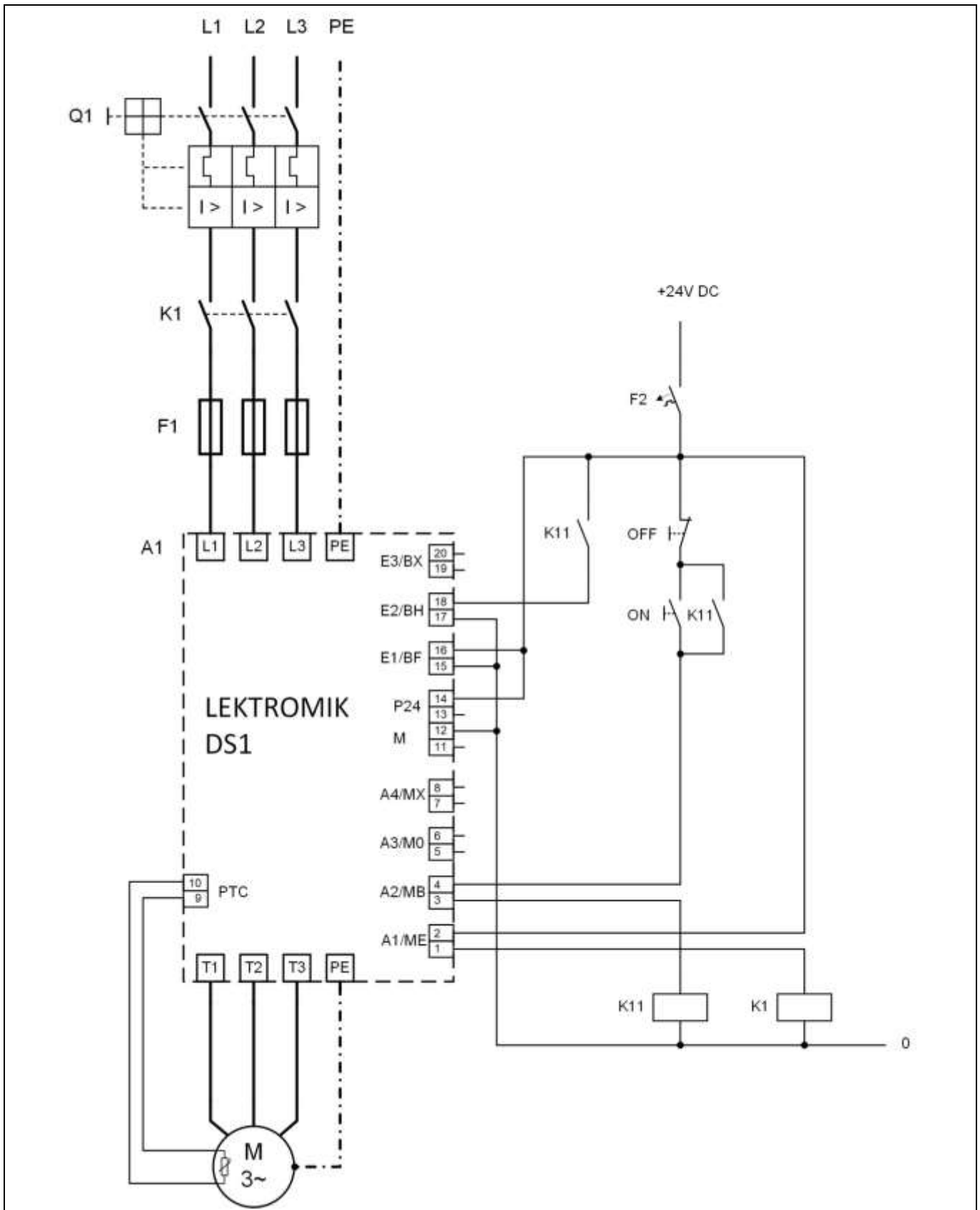

Figure 8: Connection recommendation – manual control

NOTE Input BF is parametrised to continually enabled (bridge permissible).

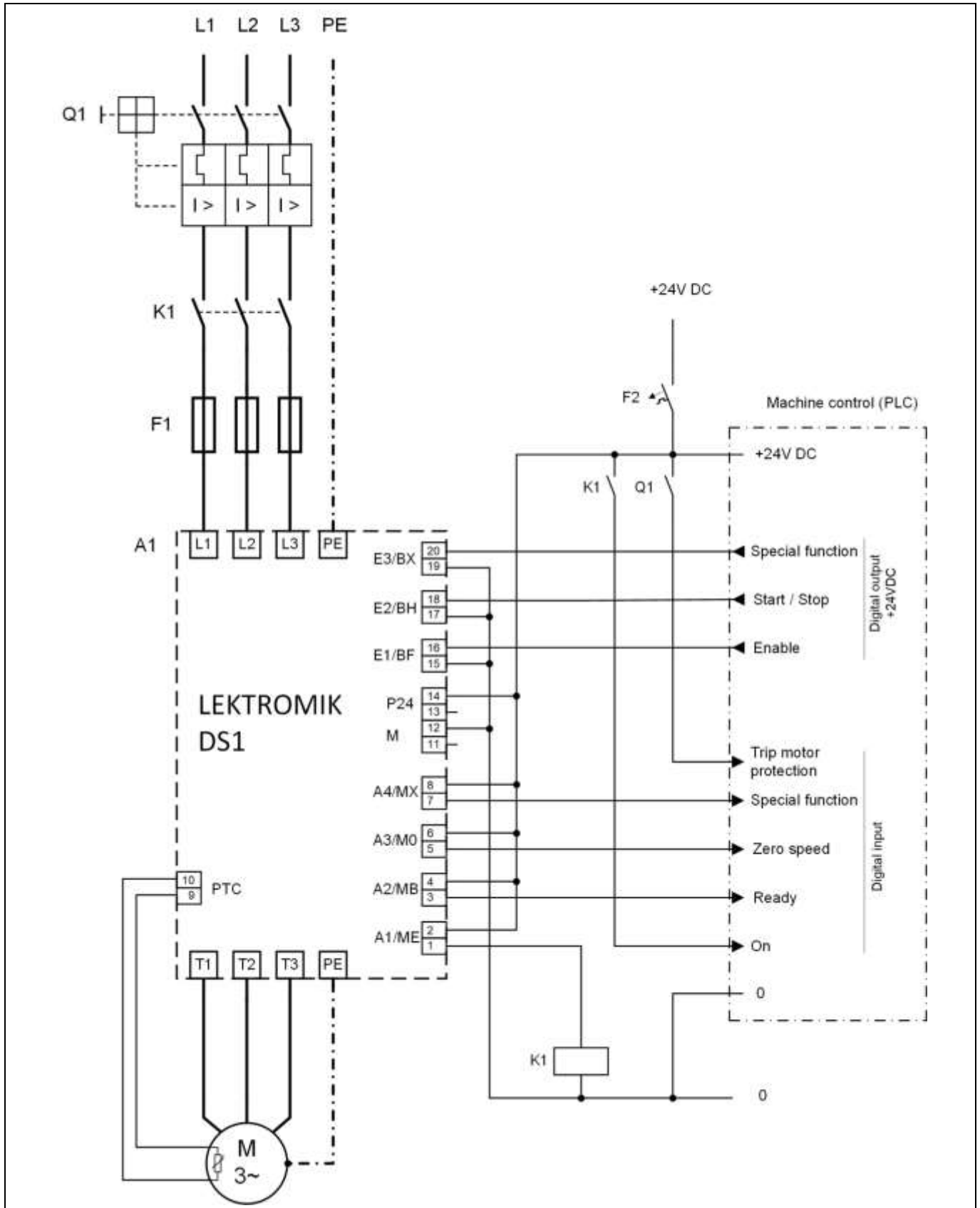

Figure 9: Connection recommendation – External control with PLC

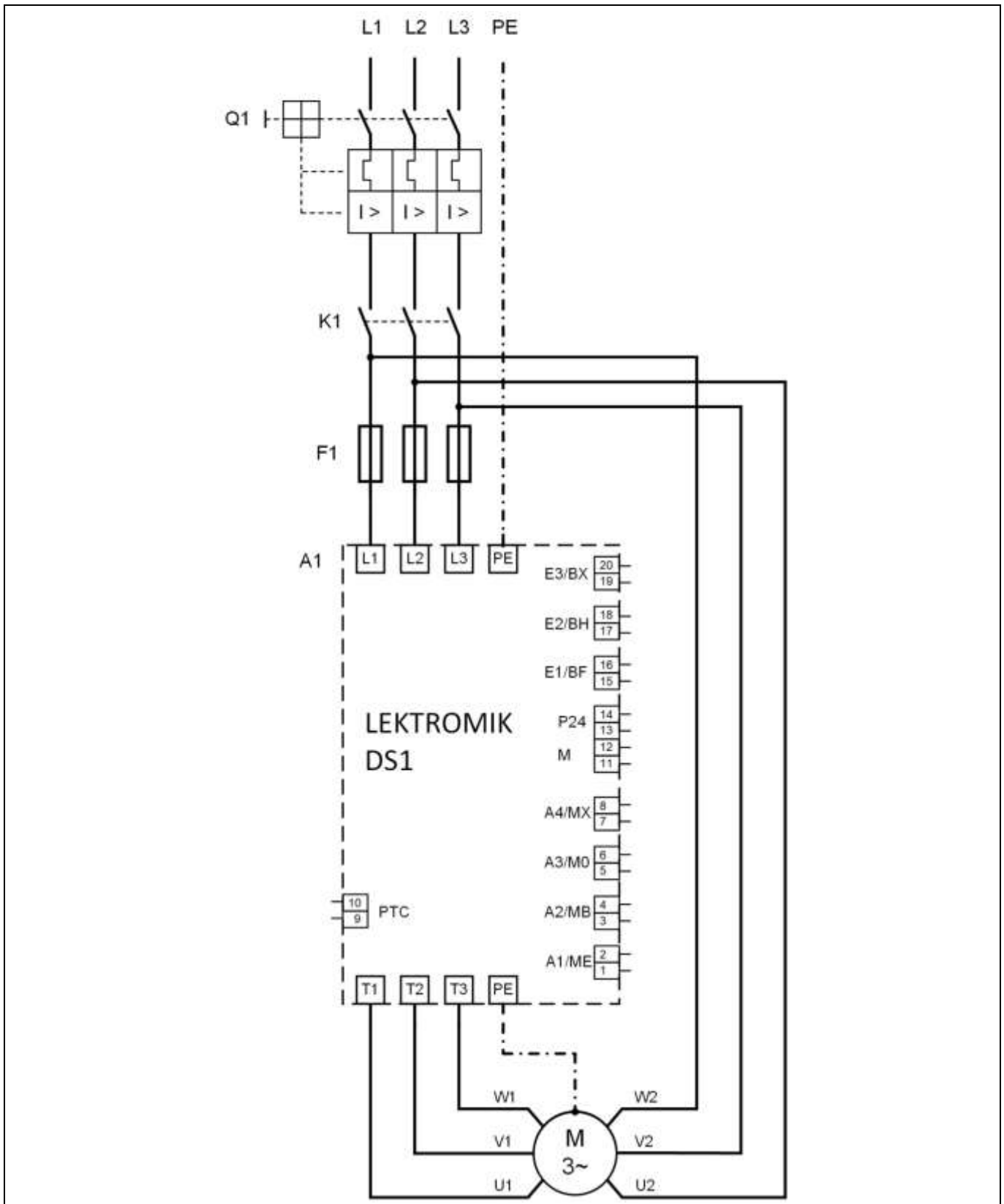

Figure 10: Connection recommendation – power circuit in delta connection

4.9 Planning the installation

General

The described units are components, which have to be incorporated into machinery, and which have a function that is determined by the construction and layout of the complete installation. It is the responsibility of the user to ensure that the machine fulfills the appropriate directives and regulations.

Drive dimensioning

The starting or stopping depends on several parameters, e.g. motor type, torque reserve, behaviour under load, gearbox type, etc. A drive design is useful for new applications. On request, the technical sales team at KIMO Industrial Electronics GmbH will support, when all important drive and load data are available.

Soft stop or d.c. injection brake

The inertia of the load and the friction are both essential for the soft stop or d.c. injection brake. If the load comes to zero speed very quickly after being switched off, the soft start/stop operating mode is sufficient. With large moments of inertia, the d.c. injection brake (operating mode soft start / braking) is required.

Heavy-duty starting

The inertia of the load and the counter torque are both essential for the heavy-duty starting. On request, the technical sales team at KIMO Industrial Electronics GmbH will support, when all important drive and load data are available.

High duty cycle

If the load (moment of inertia, friction) is known, the duty cycle limit of the motor can be determined from the motor manufacturer's data. A motor with an alloyed rotor and possibly a higher insulation class may significantly increase the duty cycle of the motor.

Power supply

Contact KIMO Industrial Electronics GmbH in the event of applications in an IT supply with a voltage higher than the rated insulation voltage.

Short-circuit and earth-fault protection

Semiconductor fuses are to be used on the motor side to protect the device from short-circuits and earth-faults. The max. permissible switch-on time I^2t is specified in the technical data (see chapter 4.5 Technical Data from page 13). Several parameters, for example line voltage, load cycle, temperature, etc., must be taken into account for the dimensioning of the fuse. For this reason it is not possible to provide specific recommendations here.

Wiring

For the wiring a suitable cable cross section (e.g. per EN 60439-1, EN 60204-1) and an appropriate short-circuit and overload protection for the wiring must be used. Additional power circuit breakers or motor overload protection breakers/ fuses are required.

Thermal protection

The LEKTROMIK® DS1 is designed for continuous operation with motors up to the stipulated power rating. A thermal overload relay, a motor overload protection breaker and ideally a motor with thermistor protection are prerequisites for the thermal protection of the controller and the motor for drives with high duty cycles. Starting current and time shall not exceed the permissible values.

Compatibility with residual current protective devices

If a residual current device (RCD) is used on the mains side of the soft starter/brake unit for protection against direct and indirect contact, it must be of type B!

$t_a + t_b$ \ $I_A, I_B / I_{Ndevice}$	3	4	5	6
2	150	100	50	30
4	75	50	25	15
6	50	33	17	10
10	30	20	10	x
15	20	13	x	x
20	15	10	x	x
30	10	x	x	x

Table 13: Permissible switching cycles

Permissible switching cycles per hour against multiples of the starting current or braking current relative to the rated current of the device and the sum of the starting and braking time.

Legend for the abbreviations:

- $I_{Ndevice}$: Rated current of the device (30A)
- I_A : Starting current
- I_B : Braking current
- t_a : Starting time
- t_b : Braking time
- x: Not permitted

Example:

- Rated motor current: 22 A
- Starting current: 5-times = 110 A
- $I_A / I_{Ndevice} = 110 \text{ A} / 30 \text{ A} = 3,67$
- $t_a + t_b = 15 \text{ s}$
- permissible switching cycles per hour: 15 (linearly interpolated)

4.9.1 EMC - Electromagnetic compatibility

The LEKTROMIK® DS1 is a drive component that does not operate independently. The electromagnetic compatibility depends on the machine/system configuration.

Emission

If using the LEKTROMIK® DS1 in industrial environments with its own transformer station (interference limit value A), no measures are required.

If using in a residential, commercial or light-industrial environment with connection to the public grid (interference limit value B), no measures are required.

Interference immunity

To assure the immunity of the product the following wiring instructions must be observed for the control cables:

- Max. 30 m cable length
- Cables longer than 3 m must be screened
- Keep as far away as possible from mains, motor or other cables that could exhibit high levels of interference

As a very high level of radio frequency (RF) interference can be emitted when switching off contactor or relay coils or electrical brakes suitable measures should be implemented.

- DC coils: Suppressor diode
- AC coils: RC-suppressor

5 Menu structure

The menu structure (main menus and sub-menus) for the LEKTROMIK® DS1 are described in table form in this chapter.

NOTE How to select and change parameters

1. Selection of a value/ a menu item turn the control knob
 2. Confirmation/acceptance of a selection push the control knob
- When changing parameters of certain menu items an additional confirmation sequence will occur.

5.1 Parameterization and password level

The LEKTROMIK® DS1 is supplied with the parameter set **Factory setting**.

When first switched on, basic settings must be made to suit the application. If further adaptations are required, this can be done in the **Edit settings** sub-menu. Input fields are identified with the symbol >. Different parameter adaptations are permitted depending on the password level.

You can obtain the corresponding passwords from your supplier of the unit (see password table, order no. 1011.103).

Password level	Application location
0	Operators can see information and can carry out changes to language and display settings. No password entry required.
1	End-users can change operating parameters and can save/load customer sets.
2	Planning the installation: Changing the basic configuration, clearing the fault memory, loading applications saved in the product.
3	KIMO Industrial Electronics GmbH test field
4	KIMO Industrial Electronics GmbH development personnel

Table 14: Password level

5.2 Initial setup menu

When first switched on or after resetting to factory settings this configuration will be interrogated..

NOTE If the initial setup is not completed, the menu will be prompted again after switching on the device anew.

Menu point	Display	Description	min	max	Factory setting	Unit	Password level
	start initial setup	Information					0
Language	Sprache/Language >English	Selection of the menu language: >Deutsch >English			Deutsch		0
Line voltage	line voltage >3AC 400 V	Rated line voltage with which the device will be operated.	200	480	400	V	0
Rated motor current	rat.mot. current >30 A	Rated current of the motor	3,0	30,0	30,0	A	0

Menu point	Display	Description	min	max	Factory setting	Unit	Password level
Operating mode	operating mode >start/braking	Operating mode: > start/braking > start/ stop > start/stop delt			Soft start / Braking		0
Rotary field monitoring	rot.field monit. >off	>off = No rotary field monitoring >on = Inhibit the device in the event of a counter-clockwise (ccw) rotating field at L1/L2/L3			Off		0
Return to the main menu	initial setup complete	Information, Return to the main menu, 5.3					

Table 15: First configuration

5.3 Main menu

Menu point	Display	Description	min	max	Factory setting	Unit	Password level
Control inputs	operating condi. E1=..E2=..E3=..	1st Line: Display active device operating condition 2nd Line: Display status of control inputs BF, BH, BX					0
Control outputs	operating condi. A1=..A2=..A3=..	1st Line: Display active device operating condition 2nd Line: Display status of control outputs MB, ME, M0					0
Control outputs	operating condi. A4=..	1st Line: Display active device operating condition 2nd Line: Display status of control output MX					0
Motor current	operating condi. I_mot =..A	1st Line: Display of active device operating condition 2nd Line: Display of motor current				A	0
Heat sink temperature	operating condi. Temp. =..°C	1st Line: Display of active device operating condition 2nd Line: Display of heat sink temperature				°C	0

Menu point	Display	Description	min	max	Factory setting	Unit	Pass-word level
Messages	display messages	Jump to Messages sub-menu, 5.4.1					0
Device information	display device info	Jump to Device information sub-menu, 5.4.2					0
Parameter list	display parameter list	Jump to Parameter list sub-menu, 5.4.12					0
Configuration	edit settings	Jump to Settings sub-menu 5.4.4					0
Display	setup display	Jump to Display sub-menu, 5.4.3					0
Language	Sprache/Language >...	Selection of menu language: >German >English (6 further languages in work)			Deutsch		0

Table 16: Main menu

5.4 Sub-menus

5.4.1 Messages sub-menu

Menu point	Display	Description	min	max	Factory setting	Unit	Pass-word level
Display messages	hhhhhhh:mmm:sss messages	1st Line: Time stamp (total operating hours) 2nd Line: Display of the last faults, warnings or messages The next message can be displayed by turning the control knob.					0
Return	quit messages	Return to the main menu, 5.3					

Table 17: Messages sub-menu

5.4.2 Device info sub-menu

Menu point	Display	Description	min	max	Factory setting	Unit	Password level
Model	type ...	Display of model					0
Order number	order number ...	Display of the order number of the device					0
Version	version ...	Display of the device version					0
Software version	software version ...	Display of the software version					0
Serial number	serial number ...	Display of the serial number					0
Rated current of the device	rat.current dev. ..A	Display of the rated current of the device				A	0
Operating time	operation total ..h:..m:..s	Display of total operating time (24 V supply present, microprocessor is working)				h: m: s:	0
Operating time	operation active ..h:..m:..s	Display of active operating time (total time of the operating conditions soft start, end of ramp-up, soft stop and braking)				h: m: s:	0
Return	quit device info	Return to the main menu, 5.3					

Table 18: Device info sub-menu

5.4.3 Display sub-menu

Menu point	Display	Description	min	max	Factory setting	Unit	Password level
Display lighting	backlight off >..s	Switch-off time for the background lighting after last input. 0 = Always on	0	60	30	s	0
Display	contrast >..	Settings for display contrast 4 = Contrast low 15 = Contrast high	4	15	8		0
Return	quit display	Return to the main menu, 5.3					

Table 19: Display sub-menu

5.4.4 Settings sub-menu

NOTE Display of sub-menu only after having entered as password.

Sub-menu can be activated only if unit is not enabled (E1/BF = 0).

Menu point	Display	Description	min	max	Factory setting	Unit	Password level
Password entry	password >0000	Digit-by-digit entry of the password					
Basic setting	basic setting	Jump to basic setup sub-menu, 5.4.5					2
Soft start	soft start	Jump to soft start sub-menu, 5.4.6					1
Soft stop	soft stop	Jump to soft stop sub-menu, 5.4.7					1
Braking	braking	Jump to braking sub-menu, 5.4.8					1
Control inputs	control inputs	Jump to control inputs sub-menu, 5.4.9					2
Control outputs	control outputs	Jump to control outputs sub-menu, 5.4.10					2
Parameter sets	save/load parameter sets	Jump to parameter sets sub-menu, 5.4.11					1
Return	quit settings	Enquiry about whether the changes made should be activated or not activated.					-
Query	all changes >	> do not activate = no changes will be adopted into the current parameter set Return to the main menu, 5.3 > activate = all changes will be adopted into the current parameter set Return to the main menu, 5.3					- -

Table 20: Settings sub-menu

5.4.5 Basic setting sub-menu

Menu point	Display	Description	min	max	Factory setting	Unit	Pass-word level
Line voltage	line voltage >3AC ..V	Rated line voltage with which the device will be operated.	200	480	400	V	2
Rated motor current	rat.mot. current >..A	Rated current of the motor	3,0	30,0	30,0	A	2
Operating mode	operating mode >...	Operating mode: > start/braking > start/ stop > start/ stop delt			Soft start / Braking		2
Rotary field monitoring	rot.field monit. >...	>off = No rotary field monitoring >on = Inhibit the device in the event of a counter-clockwise (ccw) rotating field at L1/L2/L3			Off		2
Clear fault memory	delete message memory	>yes = Clears the message memory					2
Reinstate factory setting	restore factory settings	>yes = Resets device to factory settings ¹⁾ Then jumps to Initial setup menu, 5.2					2
Return	quit basic settings	Return to Settings sub-menu, 5.4.4					

Table 21: Basic settings sub-menu

¹⁾ All operating parameters and display settings are reset to factory setting. The fault memory and the customer configurations are cleared. The language set and the operating hours counter are retained. The initial configuration is called up.

5.4.6 Soft start sub-menu

Menu point	Display	Description	min	max	Factory setting	Unit	Pass-word level
Ramp-up time	ramp-up time >..s	Duration of the run-up ramp without taking the current limit into account	1,0	20,0	5,0	s	1
Starting current	starting current >..% I _n	Limiting starting current in % of the parametrized rated current of the motor	200	600	350	%	1
Starting torque	start offset >..%	Start offset amplitude of the run-up ramp in % of the phase control factor.	0	60	0	%	1

Menu point	Display	Description	min	max	Factory setting	Unit	Pass-word level
Start pulse amplitude	startpulse ampl. >..%	Start pulse amplitude at the beginning of the run-up ramp in % of the phase control factor.	0	80	0	%	1
Start pulse duration	startpulse durat >..line periods	Duration of the start pulse	0	25	0	Line period	1
Ramp profile	ramp profile >...	Profile of the run-up ramp: > L1 linear > D1 degressive > D2 degressive > D3 degressive > P1 progressive > P2 progressive > P3 progressive > X1 combined > X2 combined			L1 linear		1
Return	quit soft start	Return to Settings sub-menu, 5.4.4					0

Table 22: Soft start sub-menu

The ramp profile of the run-up ramp can be selected for the respective application. The linear run-up ramp (factory setting) is suitable for most applications.

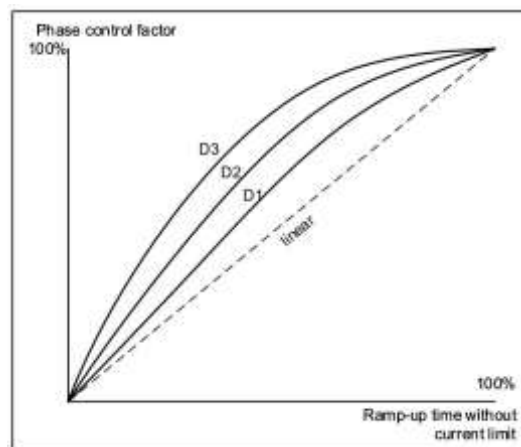

Figure 11: Degressive run-up ramps

Degressive run-up ramps are suitable for drives whose torque in the upper speed range increases more steeply than in the lower speed range, e.g. fans. With degressive run-up ramps, the modulation changes in the upper range are smaller and so more gentle on the drive.

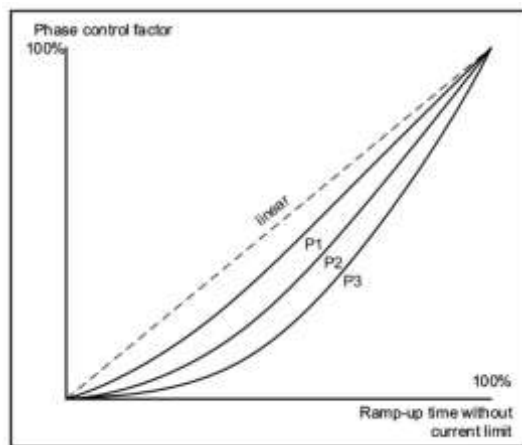

Figure 12: Progressive run-up ramps

Progressive run-up ramps are suitable for machines with gearboxes, which require a soft force connection (overcoming gearbox backlash).

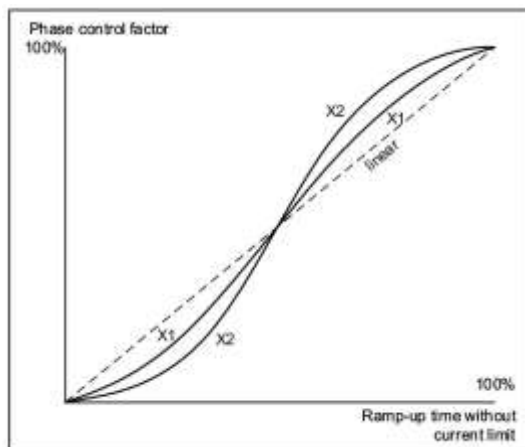

Figure 13: Combination of progressive and degressive run-up ramps

5.4.7 Soft stop sub-menu

Menu point	Display	Description	min	max	Factory setting	Unit	Password level
Ramp-down time	ramp-down time >...s	Duration of the run-down ramp	0,1	20,0	5,0	s	1
Return	quit soft stop	Return to Settings sub-menu, 5.4.4					

Table 23: Soft stop sub-menu

5.4.8 Braking sub-menu

Menu point	Display	Description	min	max	Factory setting	Unit	Pass-word level
Braking time	max.braking time >...s	Maximum braking time, if stationary motor is not detected	1,0	20,0	10,0	s	1
Braking current	braking current >...% I _n	Braking current in % of the rated current of the motor	100	500	250	%	1
Zero speed detection	zerospeed detect >...	Activation of the zero speed detection >off = zero speed is not detected >on = Zero speed is detected			Ein		1
Zero speed sensitivity	zerospeed sens. >..	Zero speed sensitivity: For adapting the zero speed detection to the motor	1	10	5		1
Braking switch-off delay	switch-off delay >...s	Switch-off delay for the braking current after zero speed has been detected	0,1	2,0	1,0	s	1
Return	quit braking	Return to Settings sub-menu, 5.4.4					

Table 24: Braking sub-menu

5.4.9 Control inputs sub-menu

Menu point	Display	Description	min	max	Factory setting	Unit	Pass-word level
Control input E1	input E1 / BF >...	Function of control input E1/BF >switch = change 0/1 necessary >bridge permiss. = continuously 1 permitted.			Switch		2
Control input E2	input E2 / BH >...	Function of control input E2/BH > switch = change 0/1 necessary >bridge permiss. = continuously 1 permitted.			Switch		2

Menu point	Display	Description	min	max	Factory setting	Unit	Password level
Control input E3	input E3 / BX >...	Function of control input 3 > no function = No function is assigned to the input >quit message = Acknowledge input >start offset = Activate the start offset >start pulse = Activate the start pulse			No Function		2
Return	quit control inputs	Return to Settings sub-menu, 5.4.4					

Table 25: Control inputs sub-menu

5.4.10 Control outputs sub-menu

Menu point	Display	Description	min	max	Factory setting	Unit	Password level
Control output A1	output A1 / ME >on	Function of relay output A1/ME - cannot be changed			On		2
Control output A2	output A2 / MB >ready	Function of relay output A2/MB - cannot be changed			Ready		2
Control output A3	output A3 / M0 >standstill	Function of relay output A3/M0 – cannot be changed			Standstill		2
Control output A4	output A4 / MX >...	Function of relay output A4/MX >no function = No function is assigned to the output >W device temp. = Warning upon exceeding the permissible device temperature >any warning = Any warnings will be issued >fault type 2 = Only type 2 faults will be issued >any fault = Any fault will be issued			W device temp.		2

Menu point	Display	Description	min	max	Factory setting	Unit	Password level
Control output A4 (continuation)	output A4 / MX >...	>bypass active = if the internal bypass relays are activated >release brake = Signal to release an external brake (optional)					
Return	quit control outputs	Return to Settings sub-menu, 5.4.4					0

Table 26: Control outputs sub-menu

5.4.11 Parameter sets sub-menu

Menu point	Display	Description	min	max	Factory setting	Unit	Password level
Save customer parameter set	save customer set	Saves the parameter set currently being processed as >customer set_1 >customer set_2 ¹⁾					1
Load customer parameter set	load customer set	Loads the parameter set for processing >customer set_1 >customer set_2					1
Load pre-configuration	load application	Loads a pre-configured parameter set (application) for processing >application 1 to 9 ²⁾					2
Return	quit parameter sets	Return to Settings sub-menu, 5.4.4					

Table 27: Parameter sets sub-menu

- 1) There are two individual customer parameter sets available. All available operating parameters are stored in these, refer to 5.4.12 Parameter list sub-menu.
- 2) In the case of the pre-configured parameter sets, the operating mode and the parameters of the sub-menus soft start, soft stop and braking are loaded. For further information refer to supplement PB-LDS1-PS, part.no. 1011.102-100.

5.4.12 Parameter list sub-menu

Menu point	Display	Description	min	max	Factory setting	Unit	Password level
Line voltage	line voltage 3AC ..V	Display of the parameter line voltage				V	
Rated motor current	rat.mot. current ..A	Display of the parameter rated motor current				A	
Operating mode	operating mode ...	Display of the parameter operating mode					
Rotary field monitoring	rot.field monit. ...	Display of the parameter rotary field monitoring					
Soft start Ramp-up time	ramp-up time ..s	Display of the parameter ramp-up time				s	
Soft start Starting current	starting current ..% I _n	Display of the parameter limit of the starting current				%	
Soft start Start offset	start offset ..%	Display of the parameter start offset				%	
Soft start Start pulse amplitude	startpulse ampl. ..%	Display of the parameter start pulse				%	
Soft start Start pulse duration	startpulse durat ..line periods	Display of the parameter duration of start pulse				Line period	
Soft start Ramp profile	ramp profile ...	Display of the current ramp profile					
Soft stop Ramp-down time	ramp-down time ..s	Display of the parameter ramp-down time				s	
Braking Max. braking time	max.braking time ..s	Display of the parameter max. braking time				s	
Braking Braking current	braking current ..% I _n	Display of the parameter braking current				%	
Braking Zero speed detection	zerospeed detect ...	Display of the parameter zero speed detection					
Braking Zero speed sensitivity	zerospeed sens. ..	Display of the parameter zero speed sensitivity					

Menu point	Display	Description	min	max	Factory setting	Unit	Pass-word level
Braking Braking switch-off delay	switch-off delay ...s	Display of the parameter switch-off delay for the braking current after zero speed has been detected				s	
Input E1/ BF	input E1 / BF ...	Display of the parameter function of input E1					
Input E2/ BH	input E2 / BH ...	Display of the parameter function of input E2					
Input E3/ BX	input E3 / BX ...	Display of the parameter function of input E3					
Output A1/ ME	output A1 / ME on	Display of the parameter function of output A1					
Output A2/ MB	output A2 / MB ready	Display of the parameter function of output A2					
Output A3/ M0	output A3 / M0 standstill	Display of the parameter function of output A3					
Output A4/ MX	output A4 / MX ...	Display of the parameter function of output A4					
Return	quit parameter list	Return to Main menu 5.3					

Table 28: Parameter list sub-menu

6 Control

This chapter contains information on the operating modes/conditions and the control inputs/outputs. The information is aimed at specialist personnel.

6.1 Control inputs

The control inputs are potential-free optocoupler inputs, controllable by a PLC or via contact with auxiliary voltage:

- Logic 1: Input energized / activated / switched on
- Logic 0: Input not energized / not activated / switched off

Control input	Command	Signal	Description
E1 / BF	enable	0	The device is or will be inhibited. No function will be carried out or a function currently being carried out (soft start, soft stop or braking) will be cancelled. The energy supply to the motor will be interrupted. WARNING No galvanic separation, if the main contactor remains active due to a fault. NOTE If BF is set to 0 during operation, the internal bypass relays open and the main contactor is still passing current, which causes increased wear on the contacts. The motor coasts to a standstill (see condition diagrams Figure 16 to Figure 18, page 40 to 41).
		1	The device is enabled. Insofar as continuous enabling is not permitted for the application, i.e. parameter input 1 / BF = Switch, a state change from 0 to 1 must take place after switching on the 24VDC control voltage to activate the command.
E2 / BH	ramp-up	0	The device changes from operating condition soft start / ramp-up to soft stop or braking depending on the configuration.
		1	The device starts the soft start or changes from operating condition standby / soft stop / braking into soft start operating condition. Insofar as a continuous ramp-up command is not permitted for the application, i.e. parameter input 2 / BH = Switch, a state change from 0 to 1 must take place after switching on the 24VDC control voltage or after deactivating the enable (BF = 0) to activate the command. The state change must take place, then BF = 1.
E3 / BX	parameterizable		Input for special functions. Use is configurable, refer to page 31, chapter 5.4.9 Control inputs sub-menu. NOTE If start offset or start pulse are parameterised, state changes after the start of the ramp-up will be ignored.
Motor-PTC	-		Input for connection of the motor temperature monitoring. Motor PTC or temperature switches are allowed.
		0	Over temperature
		1	Temperature normal NOTE If a motor PTC is not used, the input should be bridged.

Table 29: Control inputs

6.2 Control outputs

The control outputs are potential-free contacts (relay outputs).

- Logic 1: Contact closed / switched on
- Logic 0: Contact open / switched off. Condition: The device is not being in a state described under signal 1 conditions.

Control output	Message	Signal	Description
A1 / ME	on	1	<p>This output is intended for actuating the main contactor. This opens or closes the main contactor with zero current, thus significantly extended the lifetime of the contactor contacts.</p> <p>WARNING No galvanic separation, if the main contactor remains active due to a fault.</p> <p>Condition: Device is in the operating mode</p> <ul style="list-style-type: none"> • soft start or • end of ramp-up or • soft stop or • braking.
A2 / MB	ready	1	<p>This output can be used for the external enabling of the ramp-up command for example.</p> <p>Condition:</p> <ul style="list-style-type: none"> • power supply (24VDC) is present and • initialisation completed without faults and • no active fault messages present and • no configuration via the service interface or via the menu (edit settings)
A3 / M0	standstill	1	<p>Only if zero speed detection is activated.</p> <p>Condition: While in braking operating mode</p> <ul style="list-style-type: none"> • zero motor speed is detected and • enable BF is active and • no faults are present.
A4 / MX	parameterizable		Output for special functions. Use is configurable, refer to page 32, chapter 5.4.10 Control outputs sub-menu.

Table 30: Control outputs

6.3 Operating modes and conditions

The LEKTROMIK® DS1 can be operated in the following operating modes:

- Soft start – braking
- Soft start – soft stop
- Soft start – soft stop in delta connection

The following operating conditions are distinguished by the device:

- Standby
- Soft start
- End of ramp-up
- Soft stop
- Braking

6.3.1 Switch on control voltage

After the control voltage is switched on, the system checks the checksum of the data-EPROMs and the firmware memory and the initialisation of the system. The firing circuits of the thyristor modules are inhibited. The internal bypass relays and the control outputs are switched off.

Active inputs	-
Condition	-
Action	Checksum test, initialisation

Table 31: Operating condition - Switch on control voltage

6.3.2 Standby

The firing circuits of all thyristor modules are inhibited. The internal bypass relays and the control output ME is switched off. The control output MB is switched on and reports readiness.

Active inputs	-
Condition	Control voltage switched on, no internal fault messages
Action	-

Table 32: Operating condition - Standby

6.3.3 Soft start

With the **Enable** and **Ramp-up** commands given, the control output ME is first switched on (controls the main contactor). Then the motor voltage is increased with a variable ramp function (increasing phase-control firing angle) until full modulation is achieved. The starting voltage (= switch-on torque) and the voltage rise (= acceleration) can be parametrised within a large range.

In the event of the set starting current being exceeded, the run-up ramp is halted and only enabled again once the motor current has dropped again.

Active inputs	Enable and Ramp-up commands
Condition	-
Action	Soft start is initiated

Table 33: Operating condition - Soft start

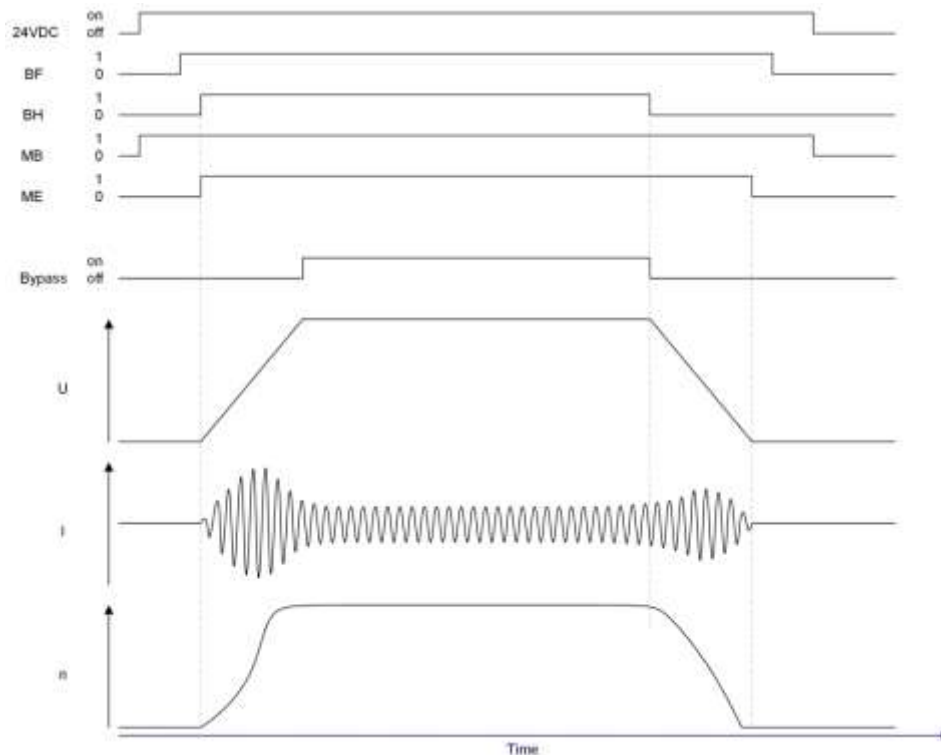

Figure 14: Condition diagram – Soft start/stop

6.3.4 End of ramp-up

If the soft start is complete, i.e. full modulation is achieved and the motor current has dropped below a defined value, the bypass relays are activated. Then the firing signals for the thyristor modules is switched off. The motor current continues to be measured in order to detect any overload that may arise. A **bypass activated** message from control output MX can be configured if required.

Active inputs	Enable and Ramp-up commands
Condition	Soft start complete
Action	Activate bypass relay, switch off firing signals for the thyristor modules

Table 34: Operating condition - End of ramp-up

6.3.5 Soft stop

The soft stop is initiated by removing the **Ramp-up** command in the **soft start – soft stop** or **soft start – soft stop in delta connection** operating mode. The thyristor modules will be brought to full modulation (max. firing angle). After a line period the bypass relays will be deactivated and the motor voltage will be decreased down to zero by a parametrised ramp function (see Figure 14: Condition diagram – Soft start/stop, page 38). If the end of ramp-up is not reached, the motor voltage is decreased down to zero via a parametrised ramp function.

After that, the firing circuits of the thyristor modules are inhibited, the control output ME deactivated and a check carried out to ascertain whether there is no longer line supply detected on connections L1, L2 and L3.

NOTE To coast the motor to standstill, the shortest ramp-down time (0.1 s) should be parametrised.

Active inputs	Enable command
Condition	Soft start – soft stop operating mode, Ramp-up command signal transition from 1 to 0
Action	Initiate soft stop

Table 35: Operating condition - Soft stop

6.3.6 Braking

The braking is initiated by removing the **Ramp-up** command in the **soft start – brake** operating mode. The thyristor modules will be brought to full modulation (max. firing angle). After one line period the bypass relays will be deactivated and then again the thyristor modules will be switched off and the firing circuits will be inhibited. If the end of ramp-up is not reached, the thyristor modules are immediately inhibited. After the brake switch-on delay, the braking thyristors are activated. The adjustable braking current determines the braking torque.

With the zero speed detection activated, the motor voltage will be assessed throughout the braking process. In doing so, the voltage induced in the winding that is not energised by the braking current will be measured. This induced voltage is an indication of a rotating motor. If during the braking process the induced voltage drops below a defined value, the adjustable braking switch-off delay time will be triggered.

The braking operation ends with the inhibition of the firing circuits of the braking thyristors, either after the braking switch-off delay time if zero motor speed has been detected, or after the maximum braking time if the motor zero speed is not monitored or has been detected (monitoring the braked ramp-down time with fault message while zero speed detection is activated).

After that, the control output ME is deactivated and a check carried out to ascertain whether there is no longer mains supply detected on connections L1, L2 and L3. If zero speed is detected at the motor during the braking process, the **Zero speed** message (M0) will now be issued.

Active inputs	Enable command
Condition	Soft start – braking operating mode, Ramp-up command signal transition from 1 to 0
Action	Initiate braking process

Table 36: Operating condition - Braking

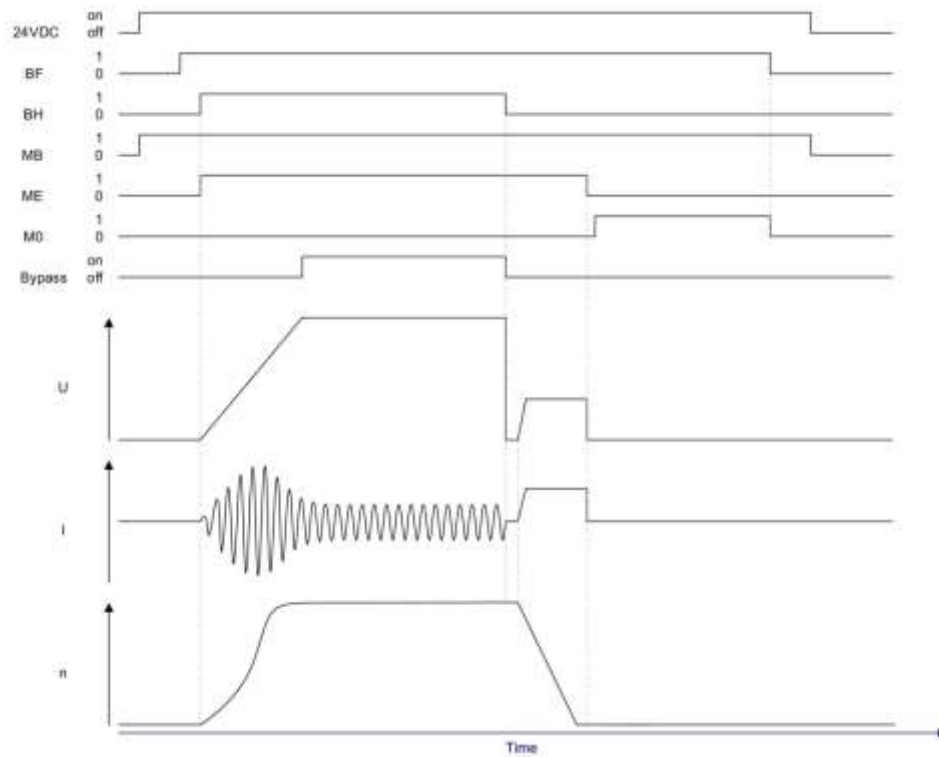

Figure 15: Condition diagram – Soft start / Braking

6.3.7 Cancellation

If BF is switched off while the motor is running, the respective operating condition is cancelled. The motor will coast to standstill.

The following condition diagram shows the behaviour of the LEKTROMIK® DS1.

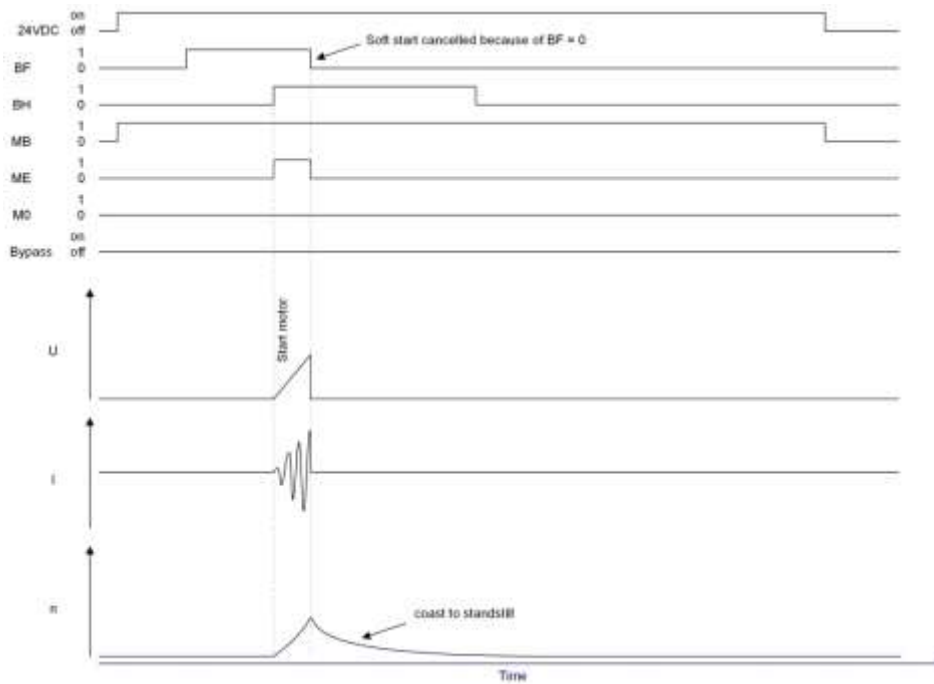

Figure 16: Condition diagram – Soft start cancelled through BF=0

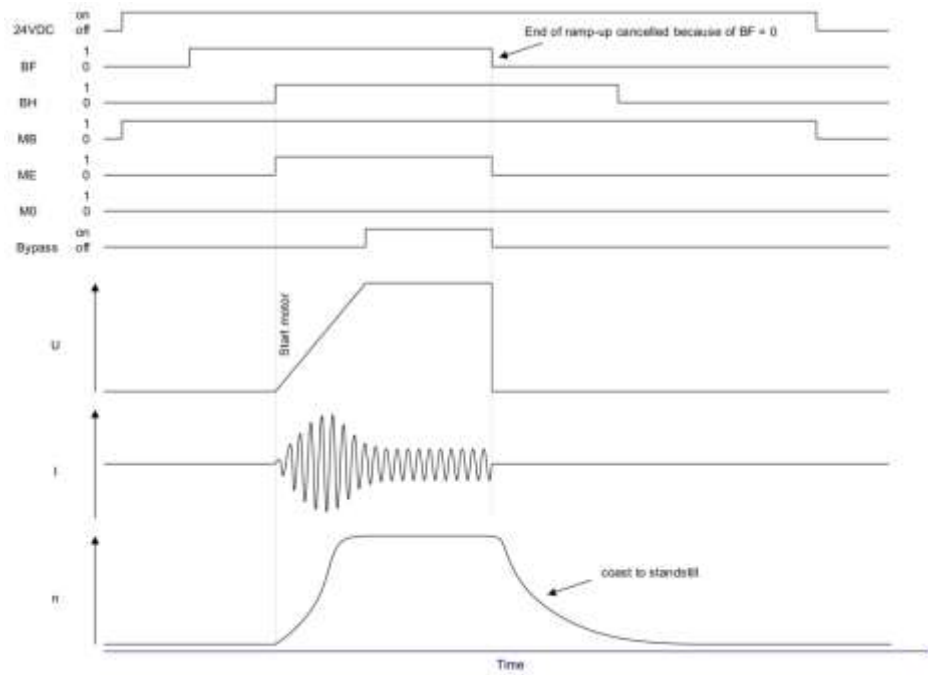

Figure 17: Condition diagram – End of ramp-up cancelled through BF=0

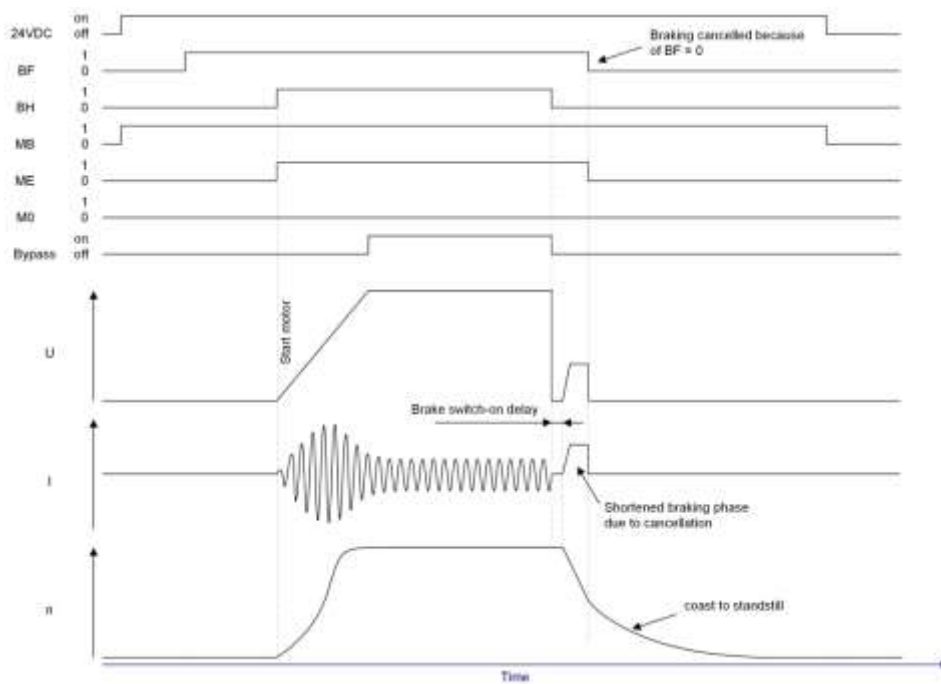

Figure 18: Condition diagram – Braking cancelled through BF=0

6.3.8 Switching off (DC 24V)

A regular switch-off is carried out after any end of a cycle.

If the control voltage is switched off while the motor is running, the motor will coast to standstill.

Active inputs	-
Condition	-
Action	All firing circuits are inhibited, all relays are OFF

Table 37: Operating condition - Switch-off (DC 24V)

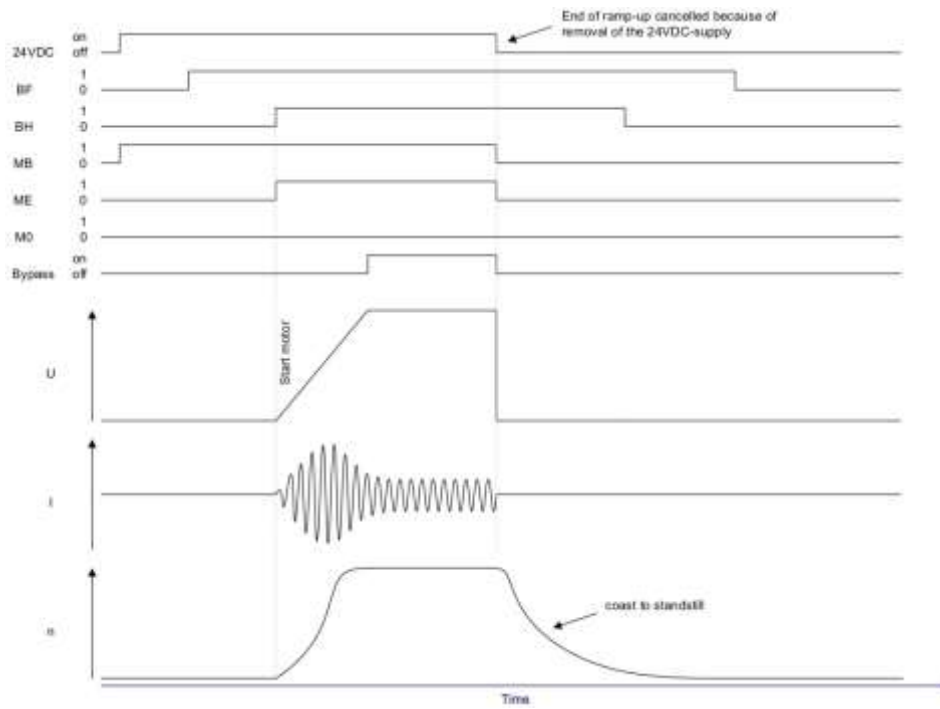

Figure 19: Condition diagram – Cancellation of End of ramp-up through removal of the 24 VDC supply

7 Appendix

7.1 Lists

7.1.1 List of figures

Figure 1: Front view	10
Figure 2: Block diagram	11
Figure 3: Display and control knob	12
Figure 4: Two-line LCD display (example)	12
Figure 5: Name plate (example)	15
Figure 6: Front and side view of the product.....	16
Figure 7: Arrangement of the connection terminals	17
Figure 8: Connection recommendation – manual control	18
Figure 9: Connection recommendation – External control with PLC	19
Figure 10: Connection recommendation – power circuit in delta connection	20
Figure 11: Degressive run-up ramps	29
Figure 12: Progressive run-up ramps	30
Figure 13: Combination of progressive and degressive run-up ramps	30
Figure 14: Condition diagram – Soft start/stop	38
Figure 15: Condition diagram – Soft start / Braking	40
Figure 16: Condition diagram – Soft start cancelled through BF=0	40
Figure 17: Condition diagram – End of ramp-up cancelled through BF=0	41
Figure 18: Condition diagram – Braking cancelled through BF=0	41
Figure 19: Condition diagram – Cancellation of End of ramp-up through removal of the 24 VDC supply	42

7.1.2 List of tables

Table 1:	Signal words	4
Table 2:	Mandatory action symbols	4
Table 3:	Warning symbols	5
Table 4:	Other signs.....	5
Table 5:	Definition of key terms	5
Table 6:	Target group matrix.....	8
Table 7:	Control knob functions	12
Table 8:	LED indicator functions	13
Table 9:	Product technical data (general).....	14
Table 10:	Technical Data – Environmental conditions	14
Table 11:	Product technical data (specific).....	15
Table 12:	Explanation – Arrangement of the connection terminals	17
Table 13:	Permissible switching cycles	22
Table 14:	Password level.....	23
Table 15:	First configuration	24
Table 16:	Main menu	25
Table 17:	Messages sub-menu.....	25
Table 18:	Device info sub-menu	26
Table 19:	Display sub-menu	26
Table 20:	Settings sub-menu	27
Table 21:	Basic settings sub-menu.....	28
Table 22:	Soft start sub-menu.....	29
Table 23:	Soft stop sub-menu.....	30
Table 24:	Braking sub-menu.....	31
Table 25:	Control inputs sub-menu.....	32
Table 26:	Control outputs sub-menu	33
Table 27:	Parameter sets sub-menu	33
Table 28:	Parameter list sub-menu.....	35
Table 29:	Control inputs.....	36
Table 30:	Control outputs.....	37
Table 31:	Operating condition - Switch on control voltage	38
Table 32:	Operating condition - Standby	38
Table 33:	Operating condition - Soft start	38
Table 34:	Operating condition - End of ramp-up.....	39
Table 35:	Operating condition - Soft stop	39
Table 36:	Operating condition - Braking	39
Table 37:	Operating condition - Switch-off (DC 24V).....	41